

MET 1-PHASE CONTROL AND ISOLATION TRANSFORMER

P: 630VA IN: 400VAC+/- 5% OUT: 230VAC

Single-phase - Control and Isolation Transformers
630 VA
Isolation class T 60/B

[Link to Product](#)**Illustration**

Product may differ from Image

Approvals**Input**

Input voltage	400 V AC $\pm 5\%$
Frequency	50...60 Hz
Short-circuit current	68.2 A (400 V AC)
Input current	1.71 A (400 V AC)
Inrush current	27.16 A (400 V AC)

Output

Output voltage	230 V AC
Output rating	630 VA

General data

Standards	EN 61558-1, EN 61558-2-4, EN 62041 category 0
Test isolation voltage	4 kV (prim./sec.)
Dimensions H×W×D	130×150×146 mm
Fixing centers a×b×c	107.5×122×7 mm
Drill hole \varnothing	7×11 mm
Mounting method	Key-hole mounting
Temperature range	-20...+60 °C (storage temperature -40...+80 °C)

Commercial data

country of origin	CZ
customs tariff number	85043180
EAN	4048879078993
eClass	27031302
Packaging unit	1

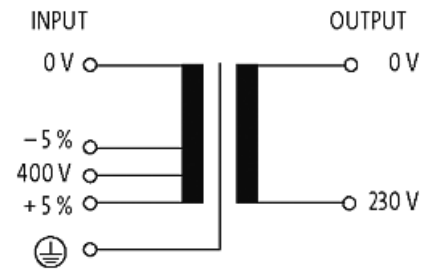
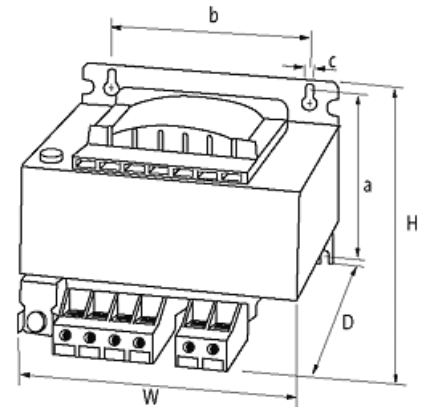
Sketch

Product may differ from Image